

PROJEKTIKUVA.Krister Lindbäck.20230325b

ASIAKAS
Krister Lindbäck

PROJEKTI
M: JSm



PROJEKTI NO.

PVM
25.03.2023

SUUNNITTELIJA
Diplomi-insinööri
JHn

KUVAUS
S3-34



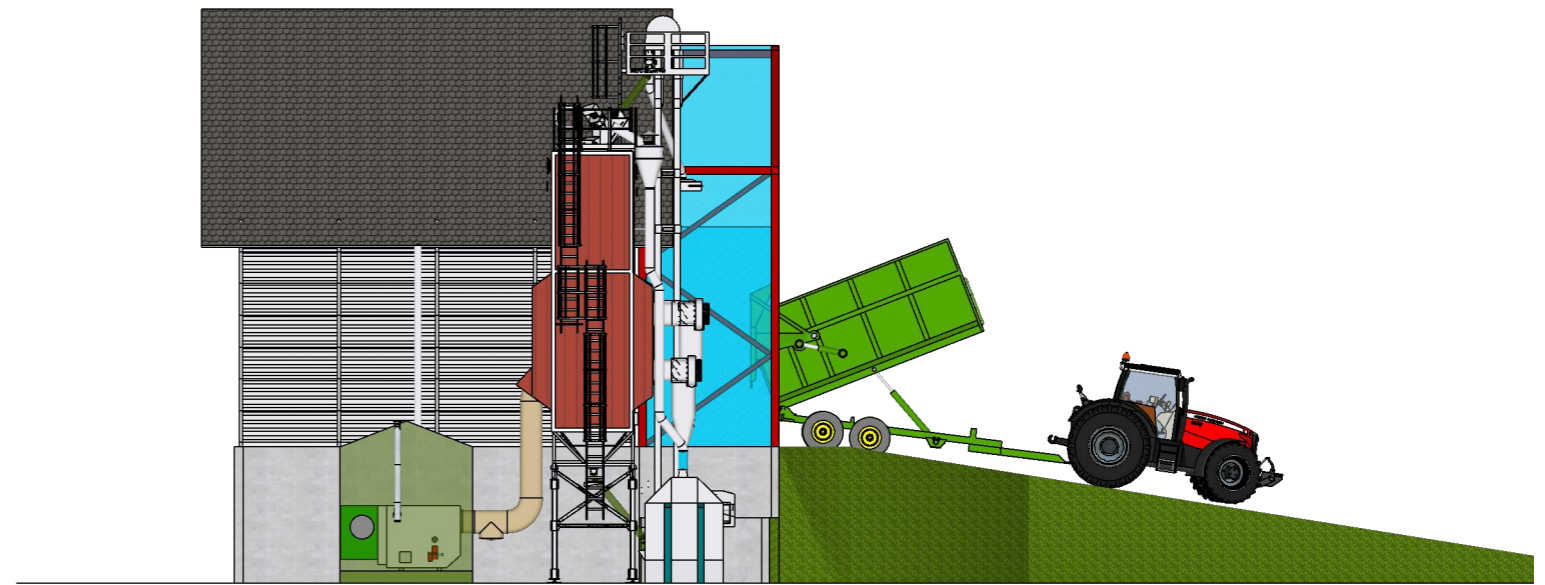
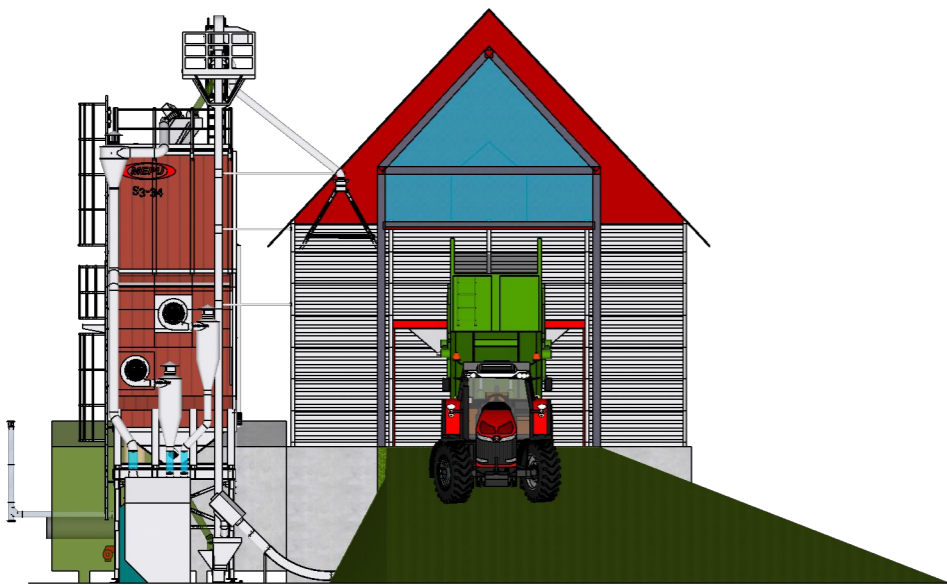
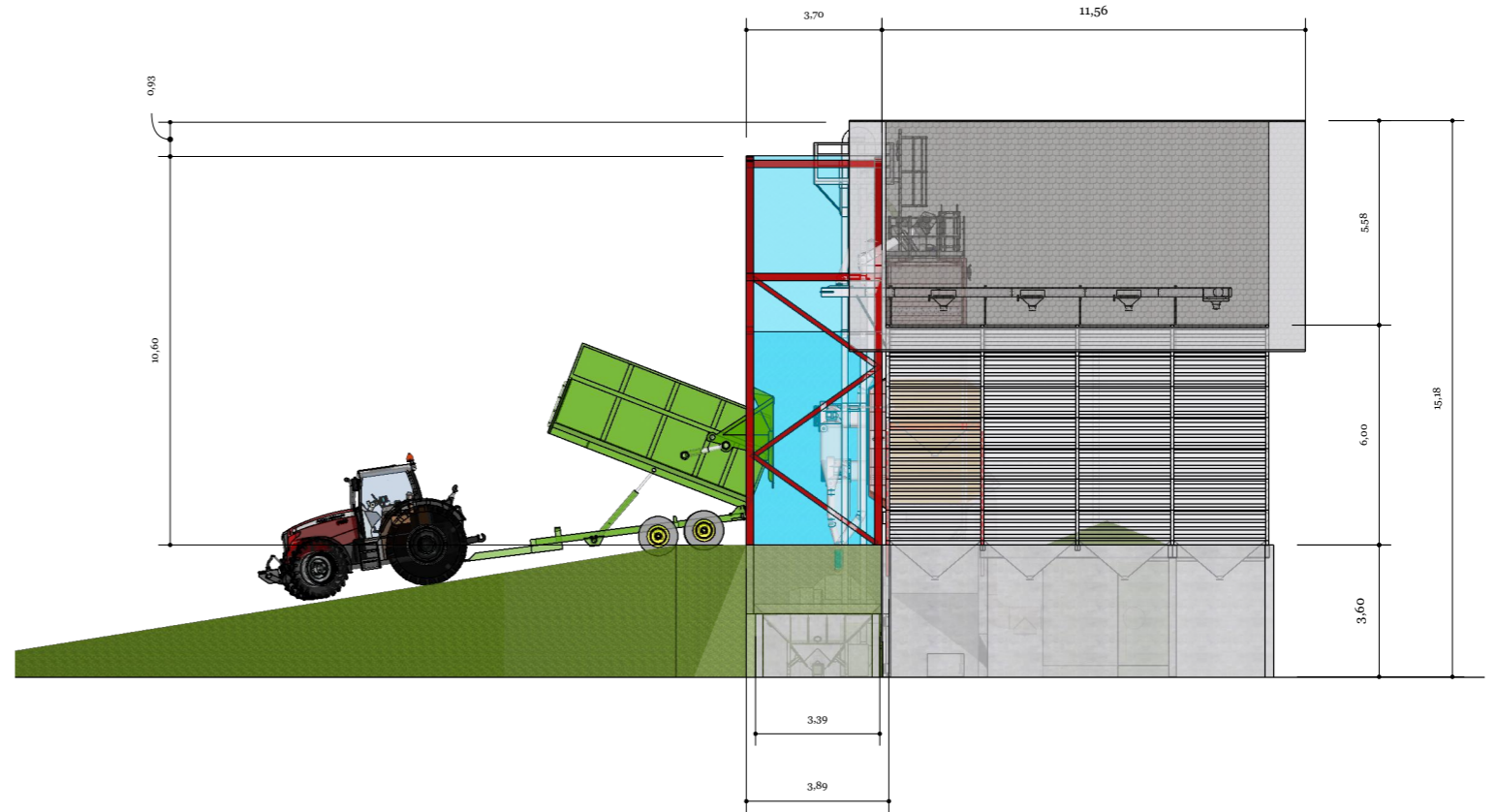
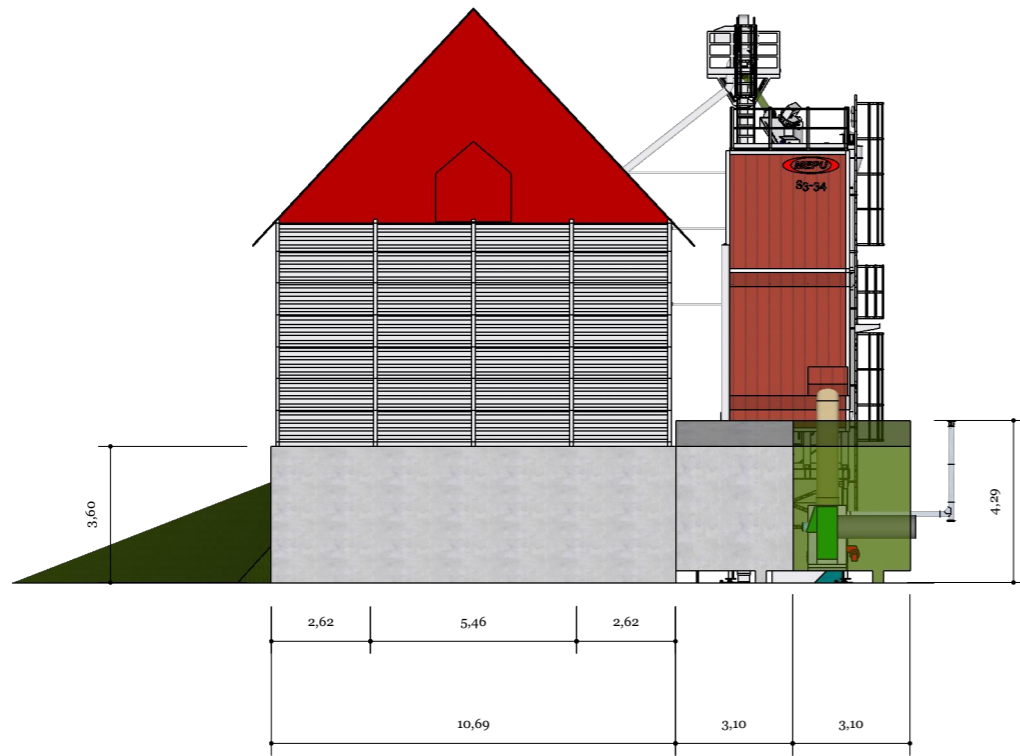

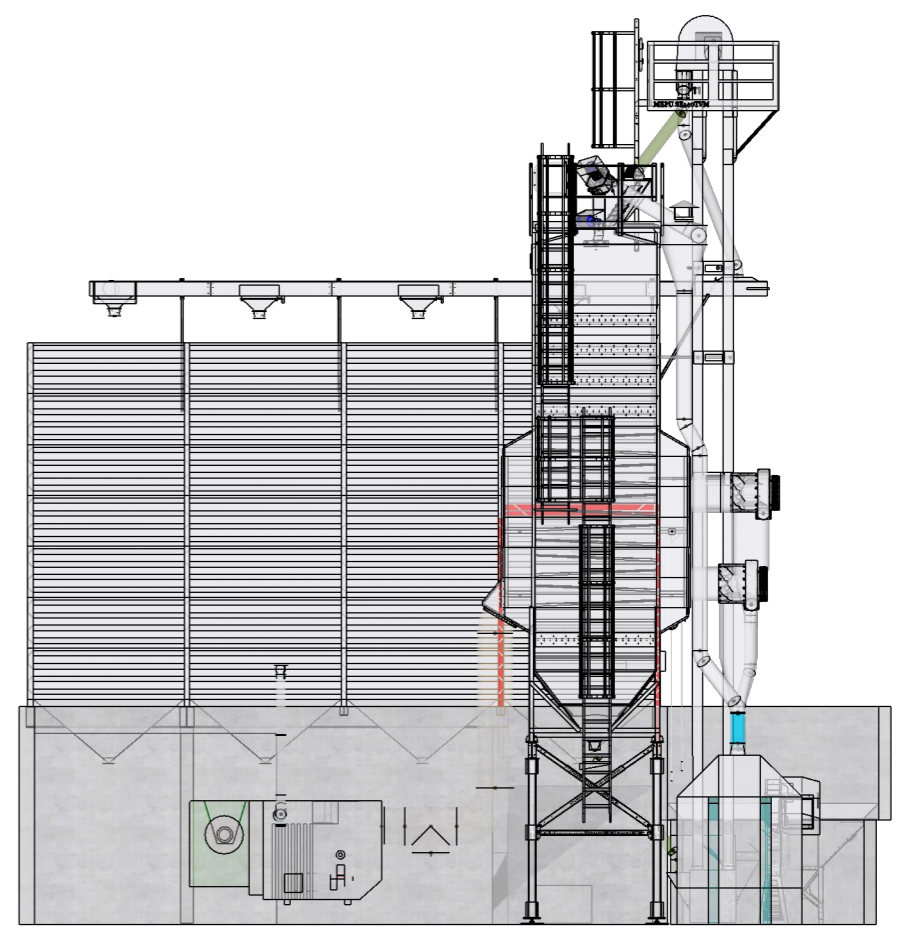
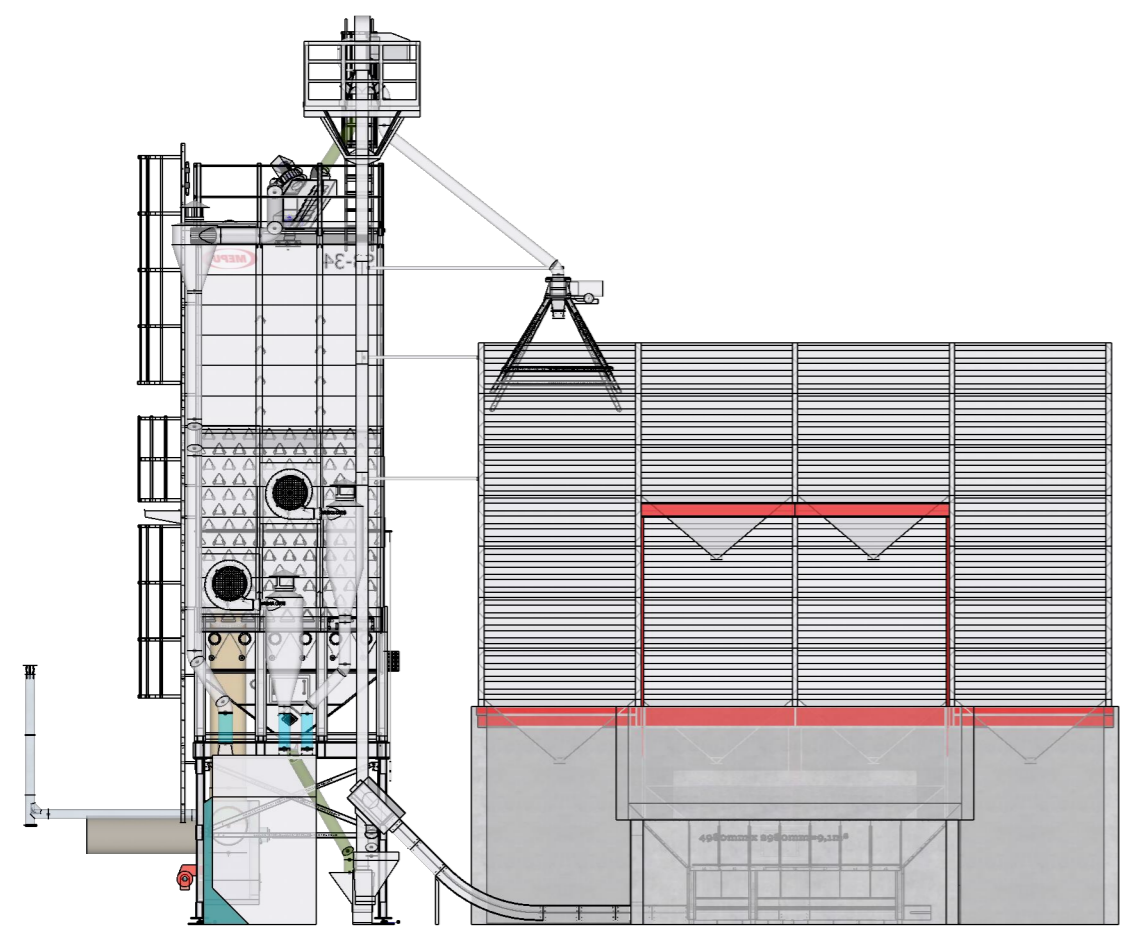
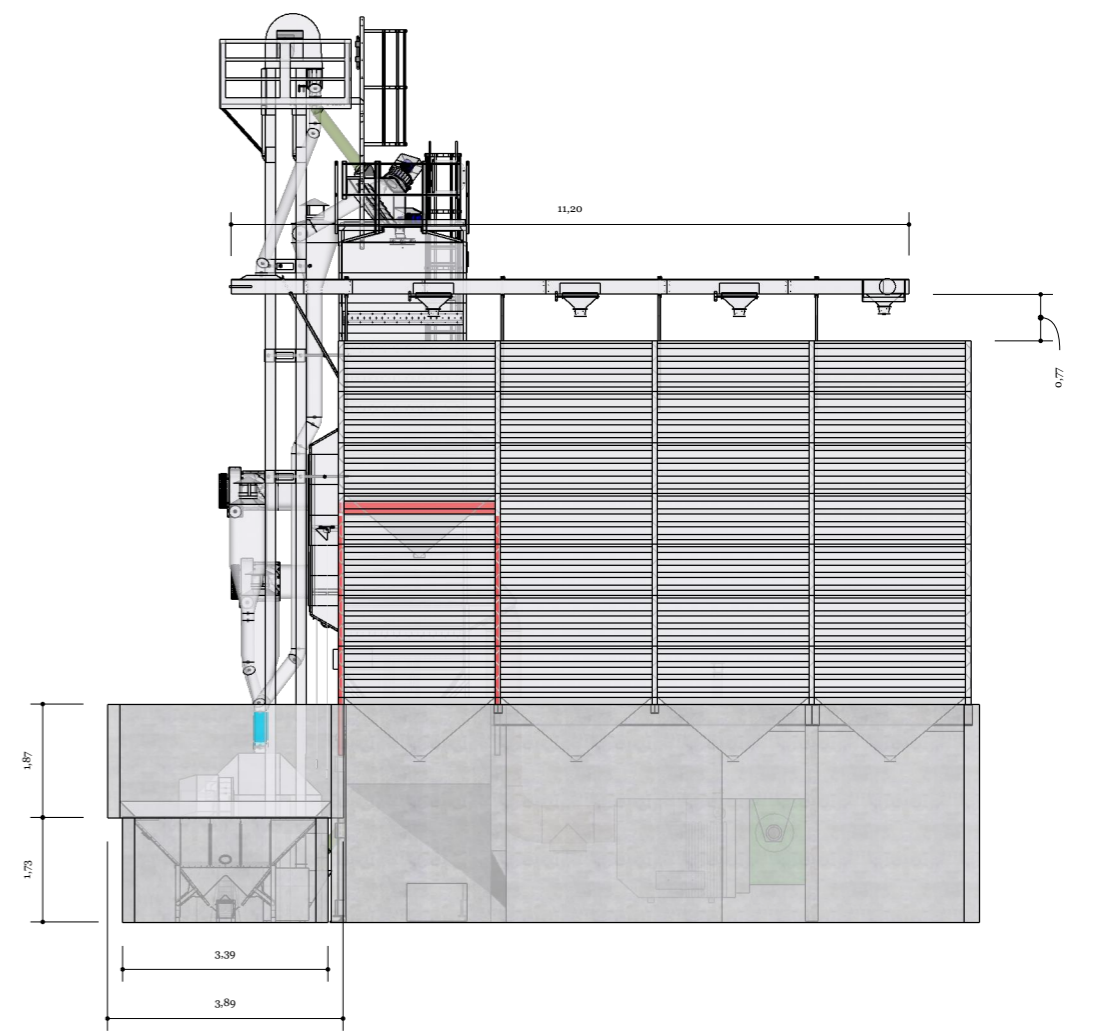
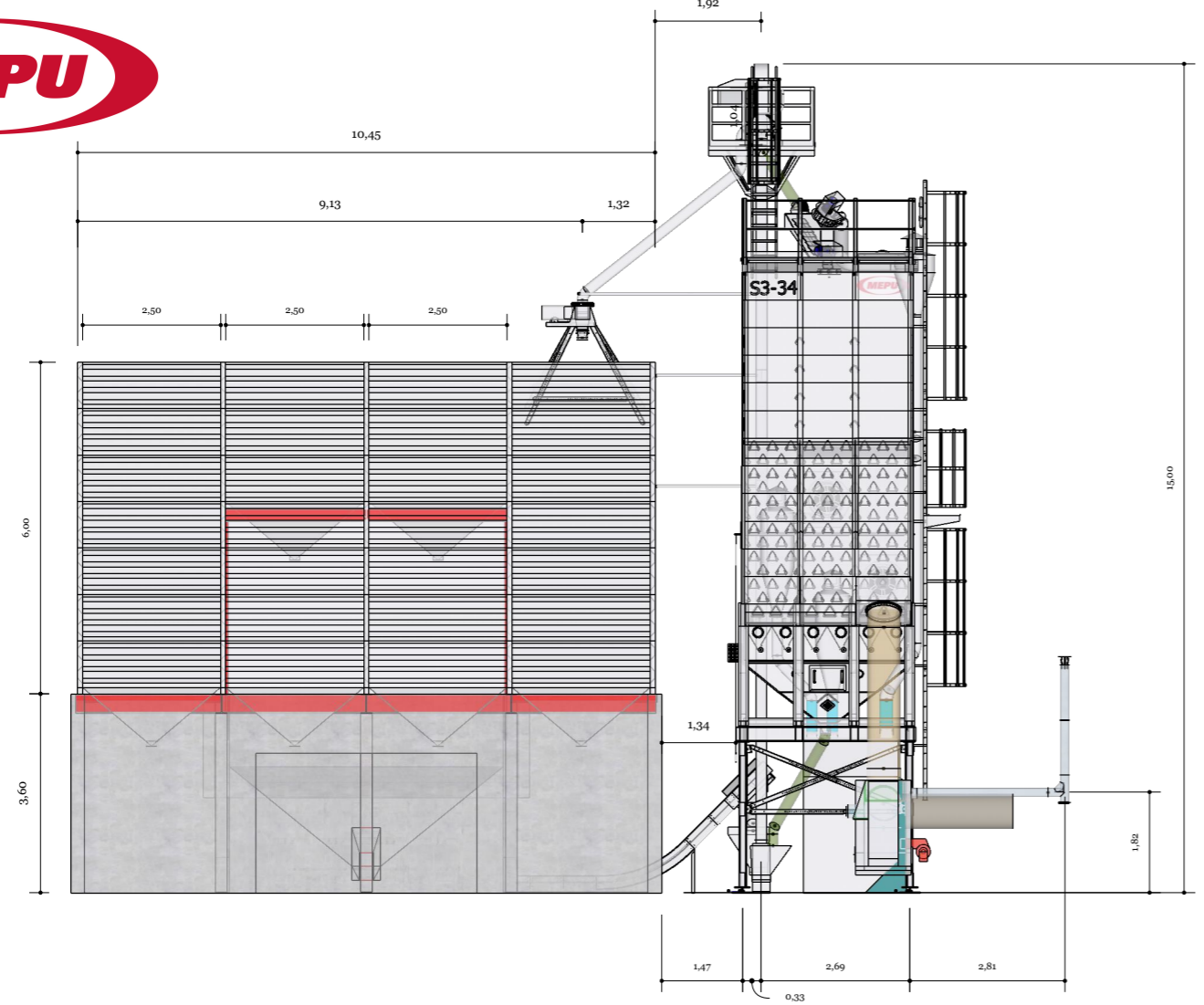

PROJEKTIKUVA.Krister Lindbäck.20230325b	ASIAKAS Krister Lindbäck	PROJEKTI M: JSm	PROJEKTI NO.	PVM 25.03.2023	SUUNNITTELIJA Diplomi-insinööri JHn	KUVAUS S3-34
---	-----------------------------	--------------------	--------------	-------------------	---	-----------------



MEPU

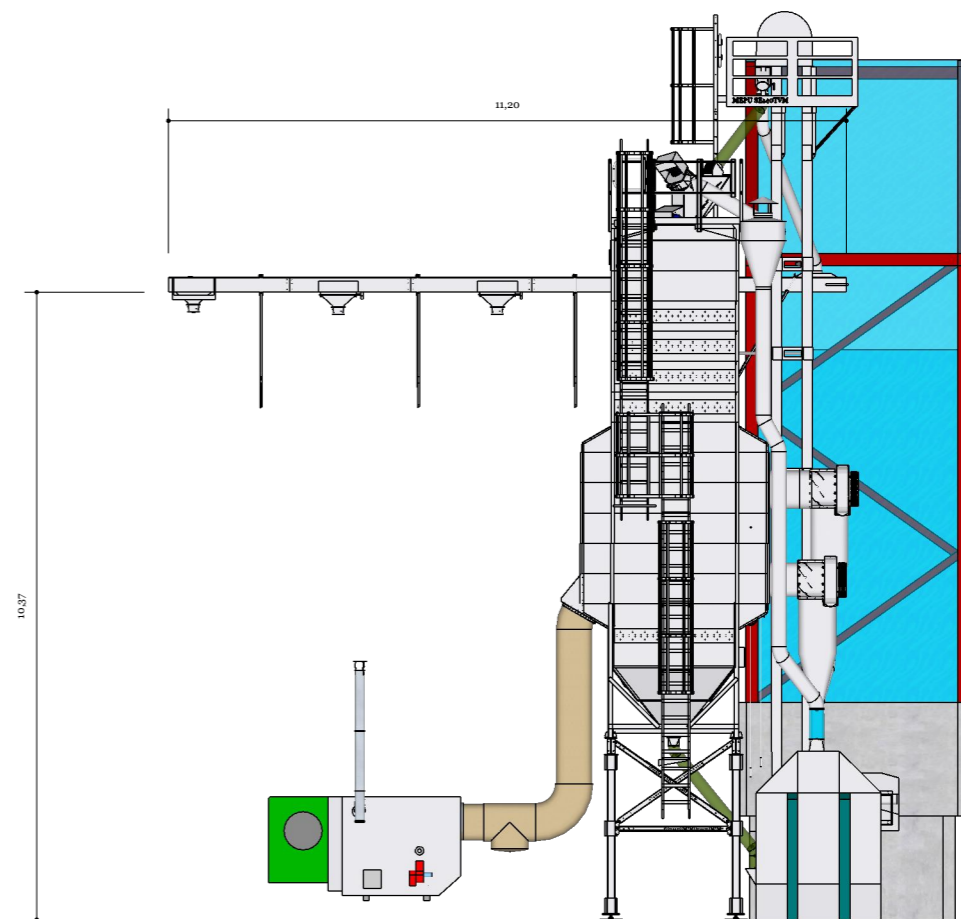
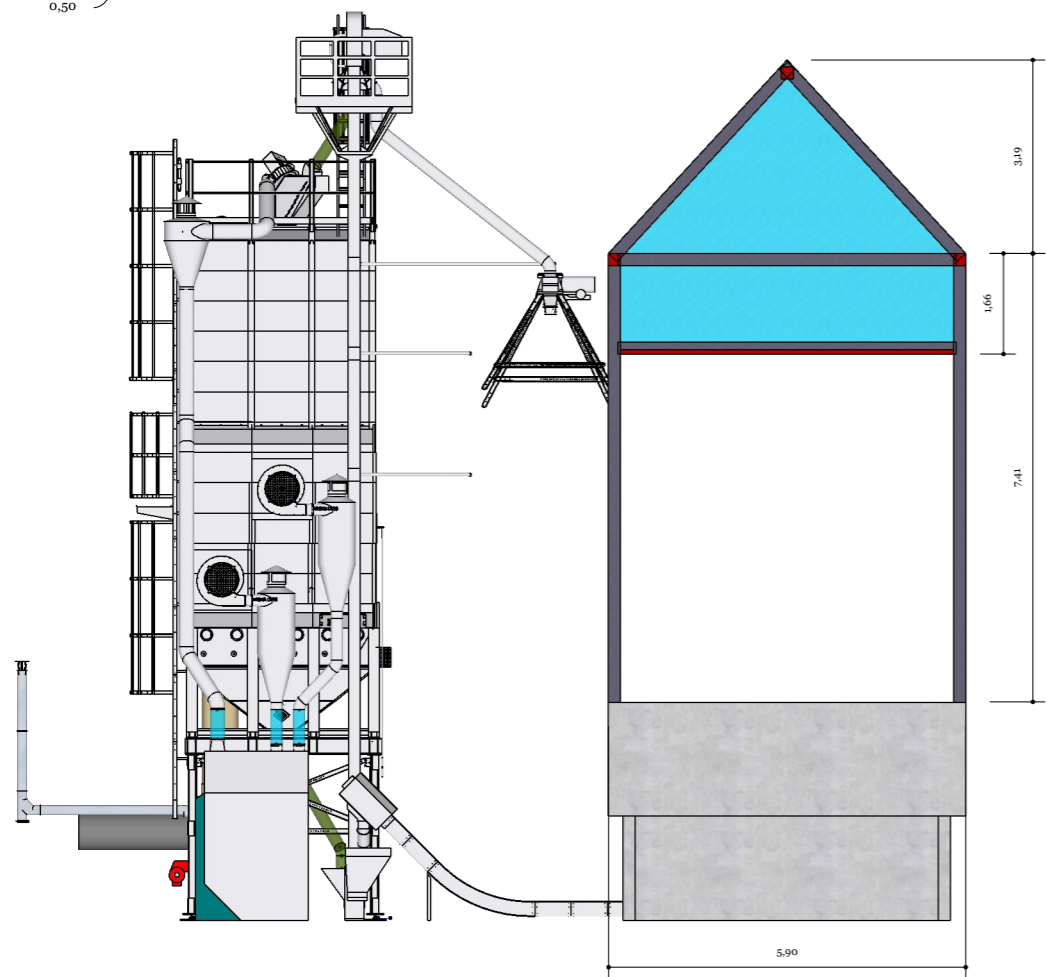
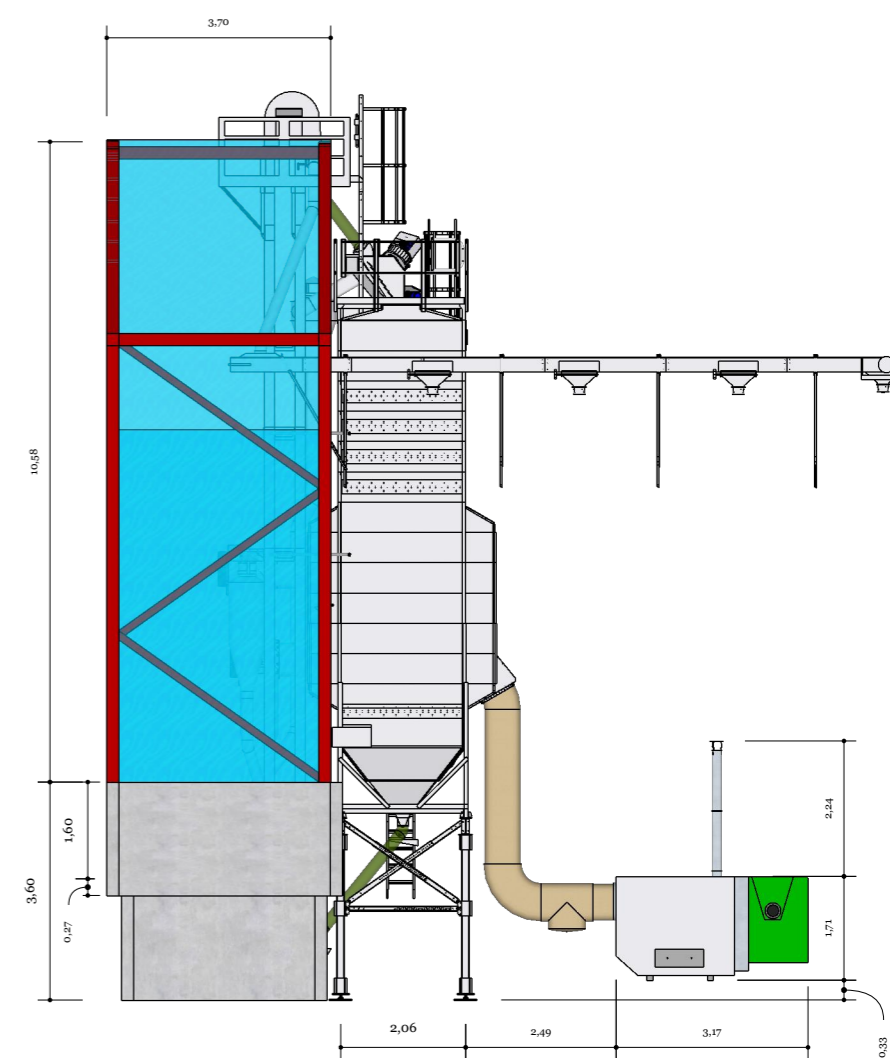
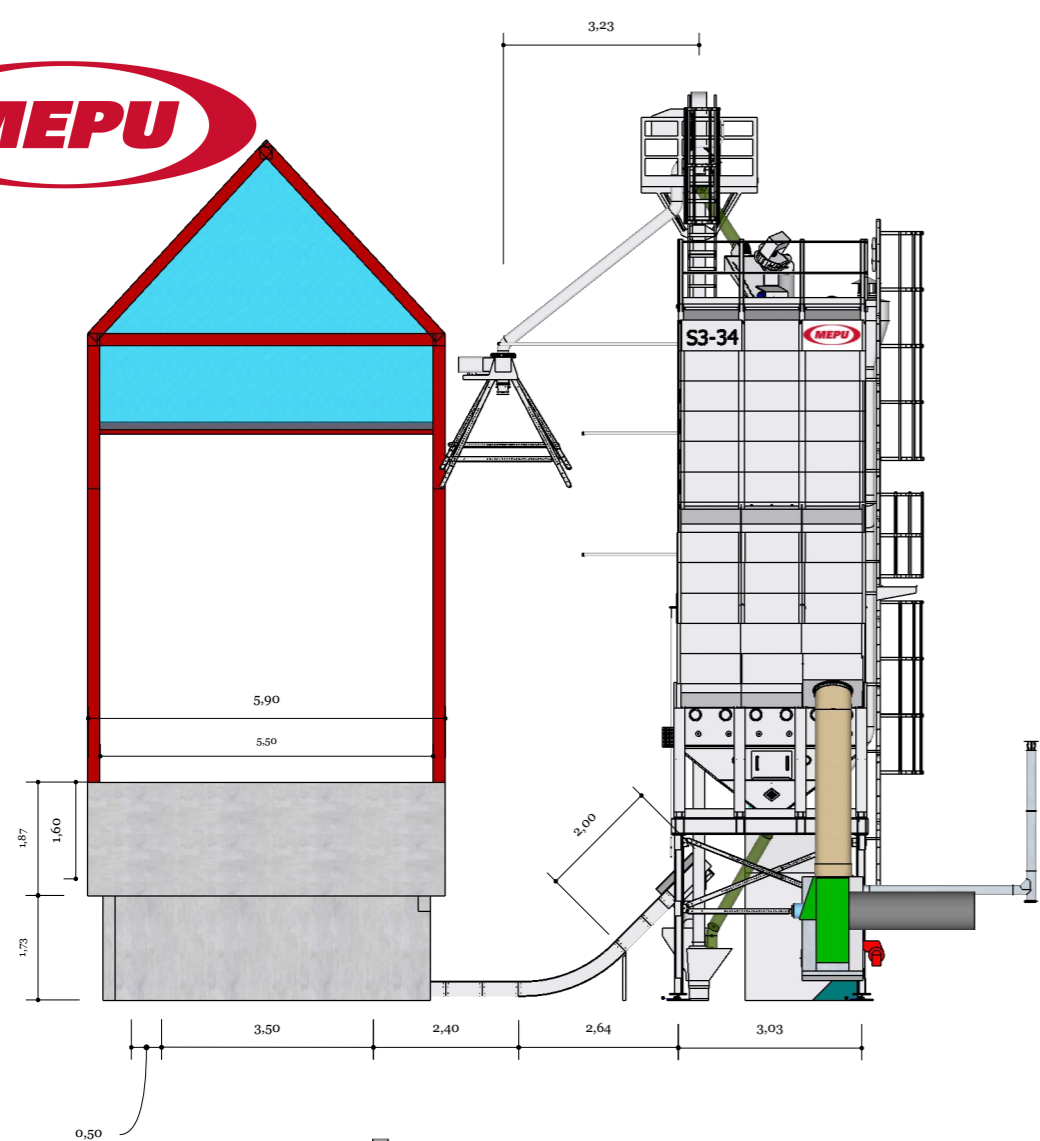

PROJEKTIKUVA.Krister Lindbäck.20230325b

ASIAKAS
Krister Lindbäck

PROJEKTI
M: JSm



PROJEKTI NO.

PVM
25.03.2023

SUUNNITTELIJA
Diplomi-insinööri
JHn

KUVAUS
S3-34



