

M240k

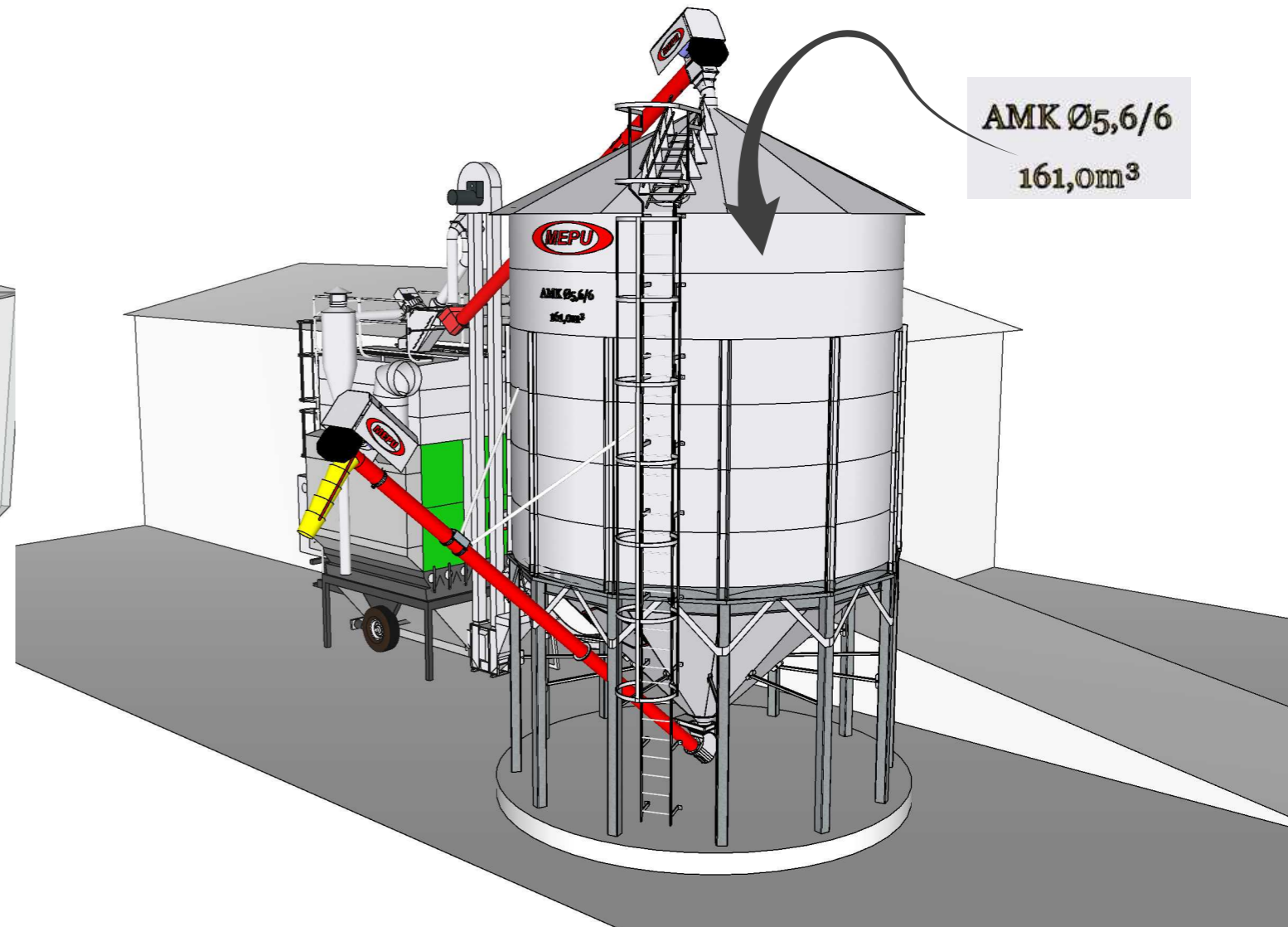

AMK Ø5,6/6
161,0m³

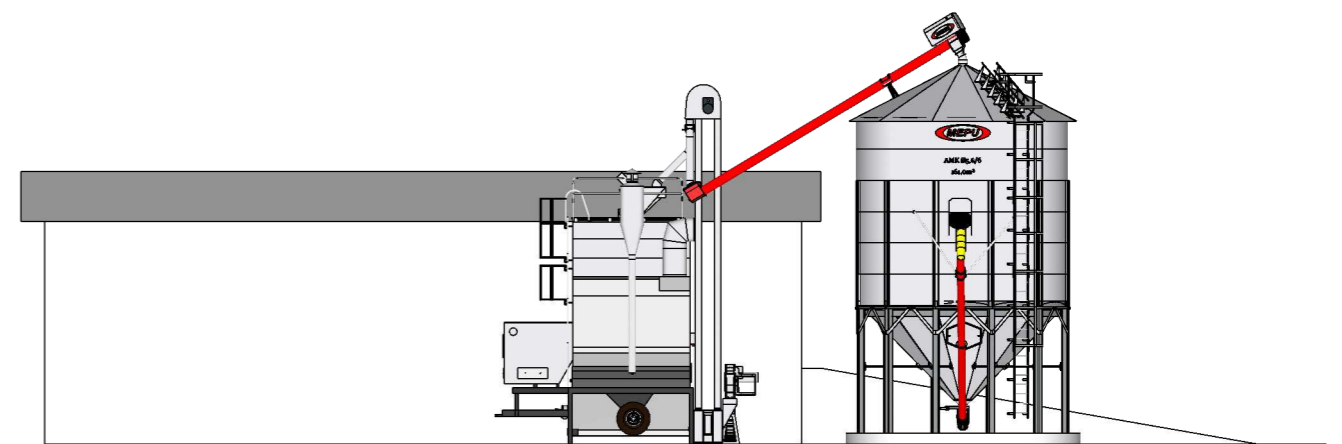

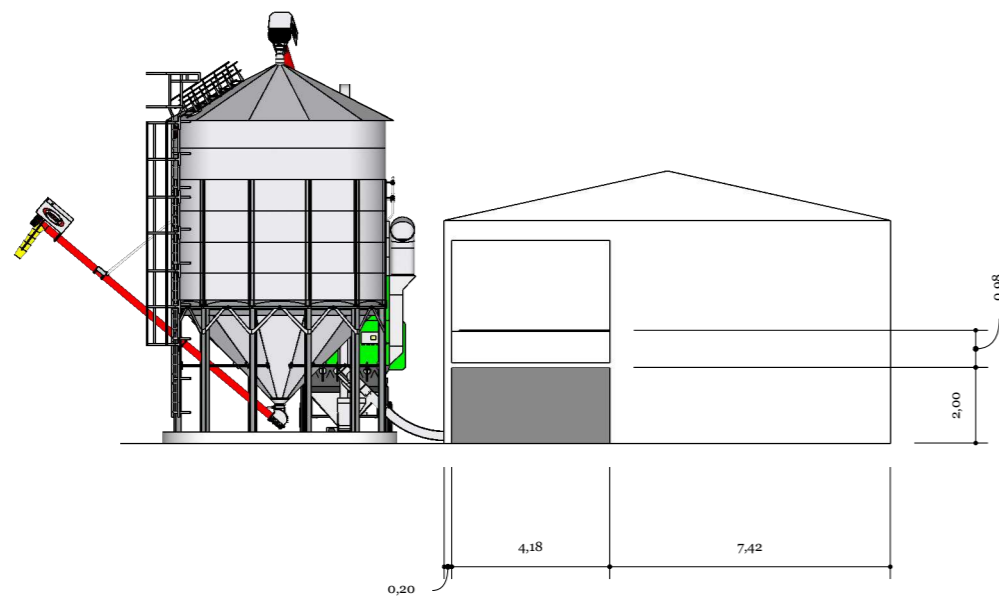
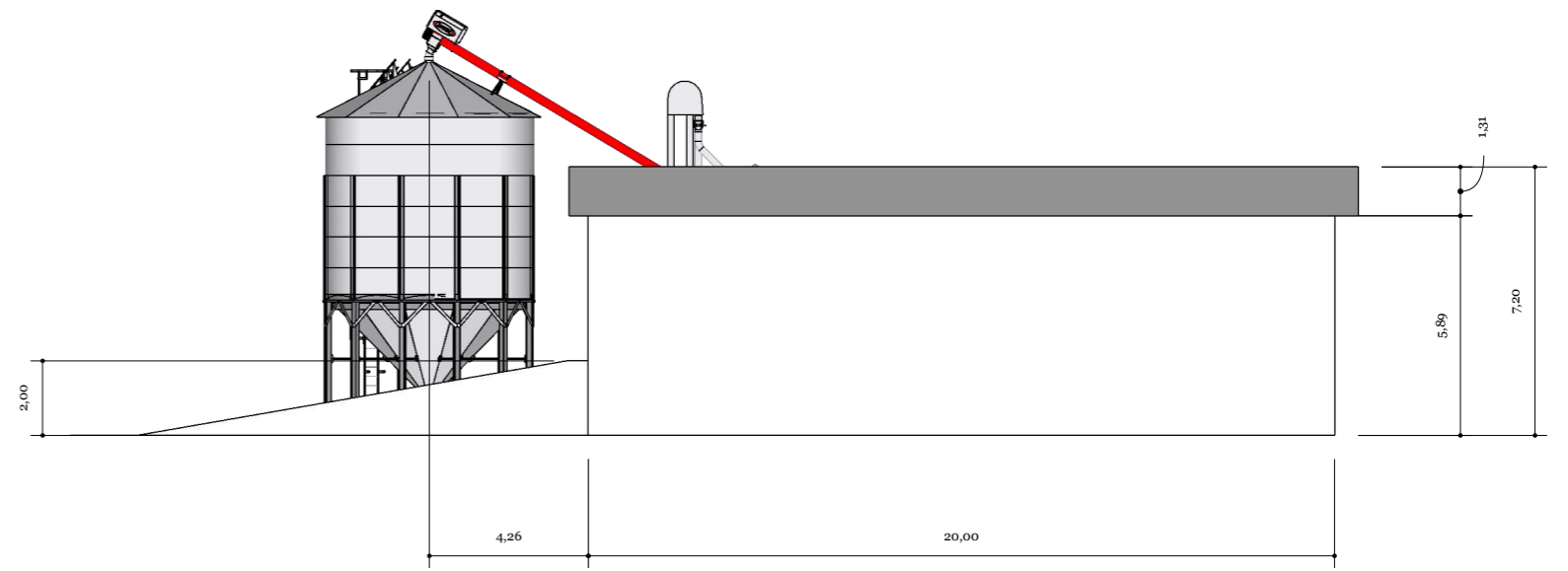
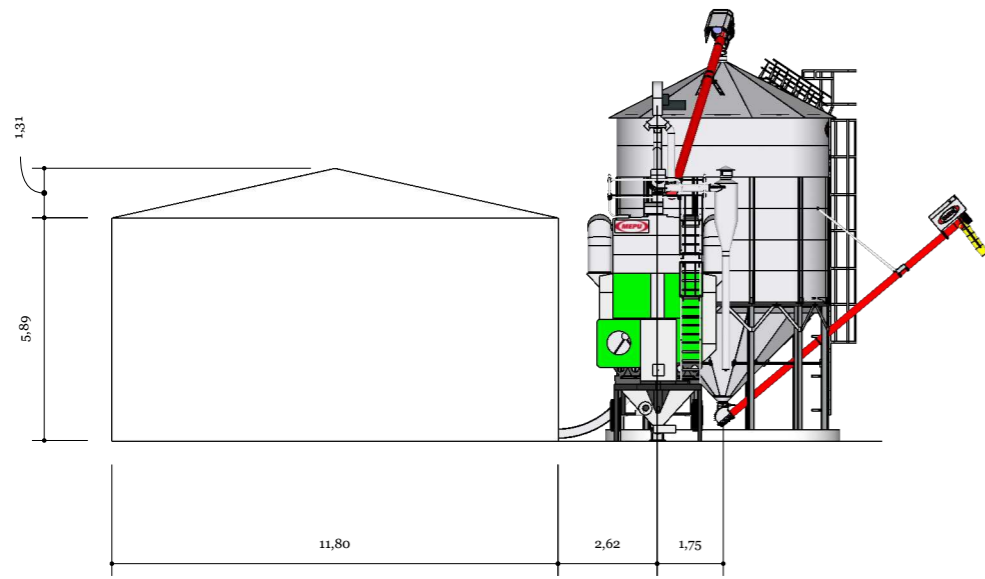

PROJEKTIKUVU.Mikko Härkönen.20230629

ASIAKAS
Mikko Härkönen

PROJEKTI
M: JSm



PROJEKTI NO.

PVM
29.06.2023

SUUNNITTELIJA
Diplomi-insinööri
JHn

KUVAUS
M240k





SE140TVM 60t/h 9,5m 3,0kW

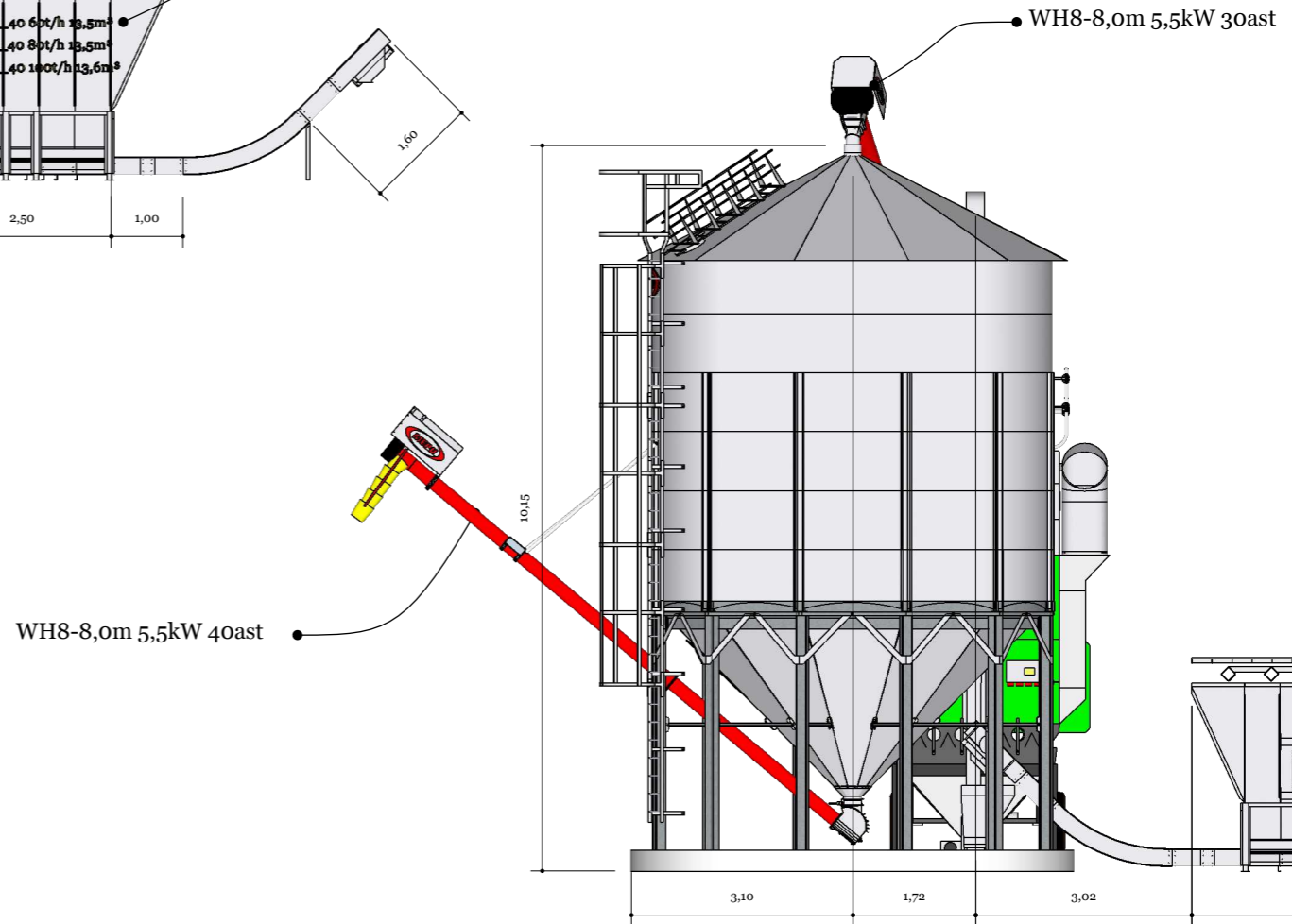
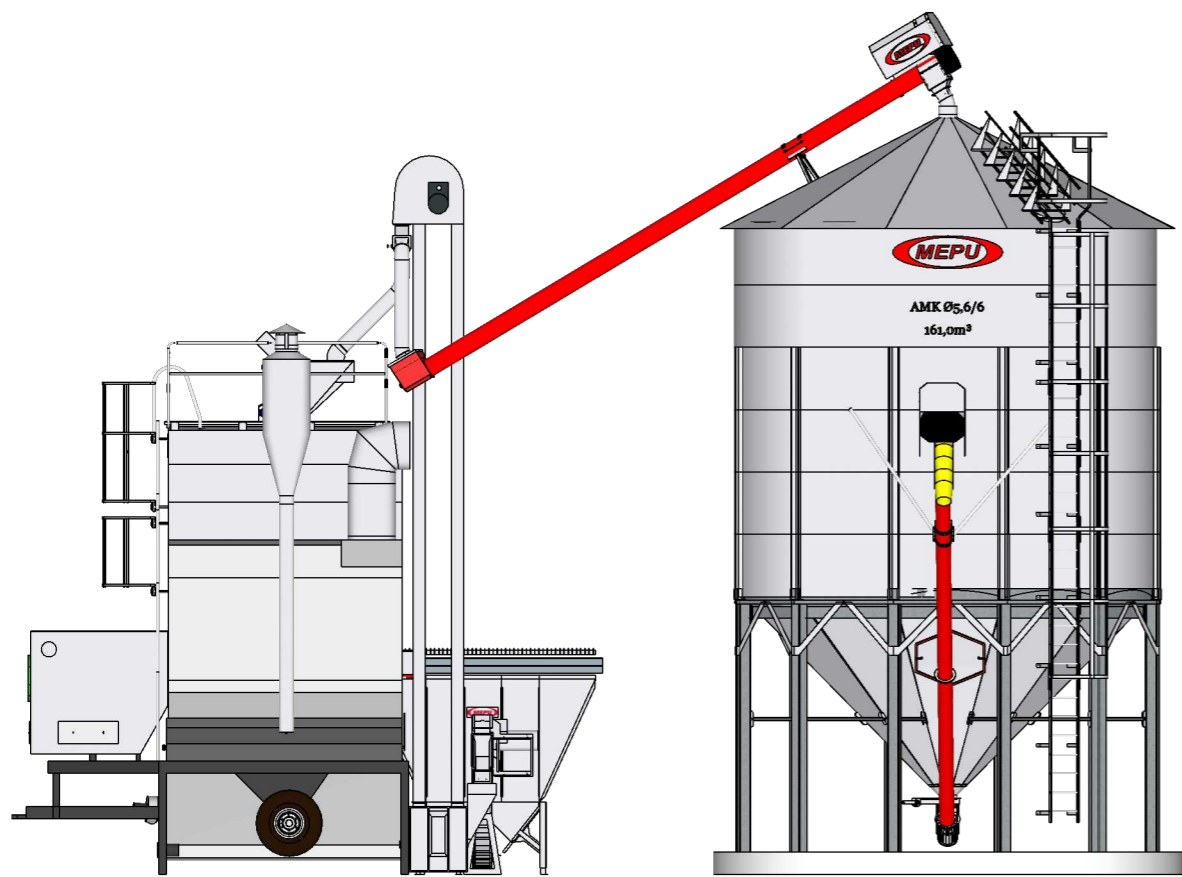
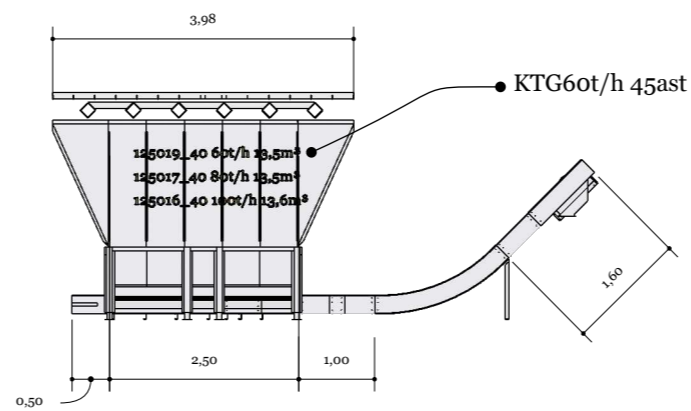
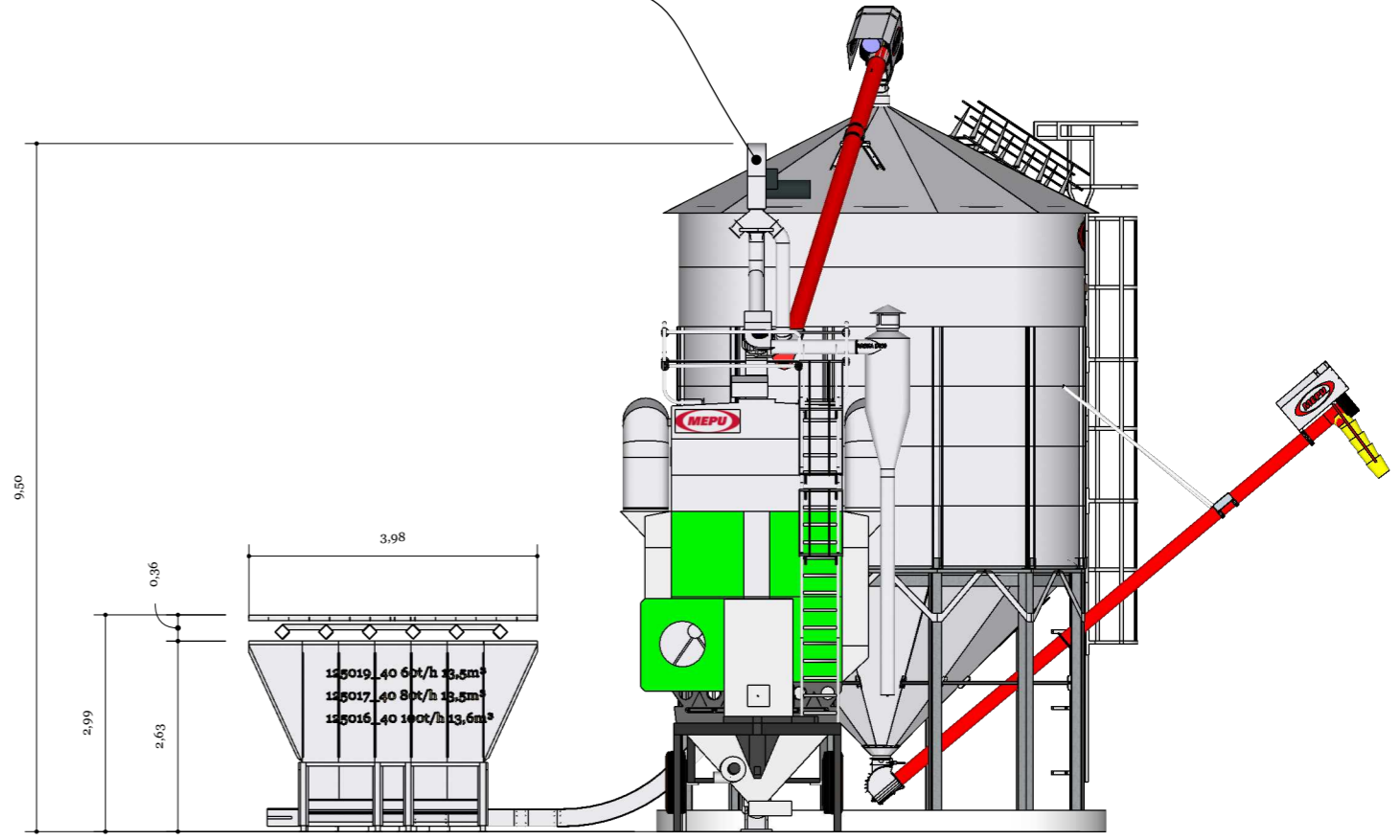
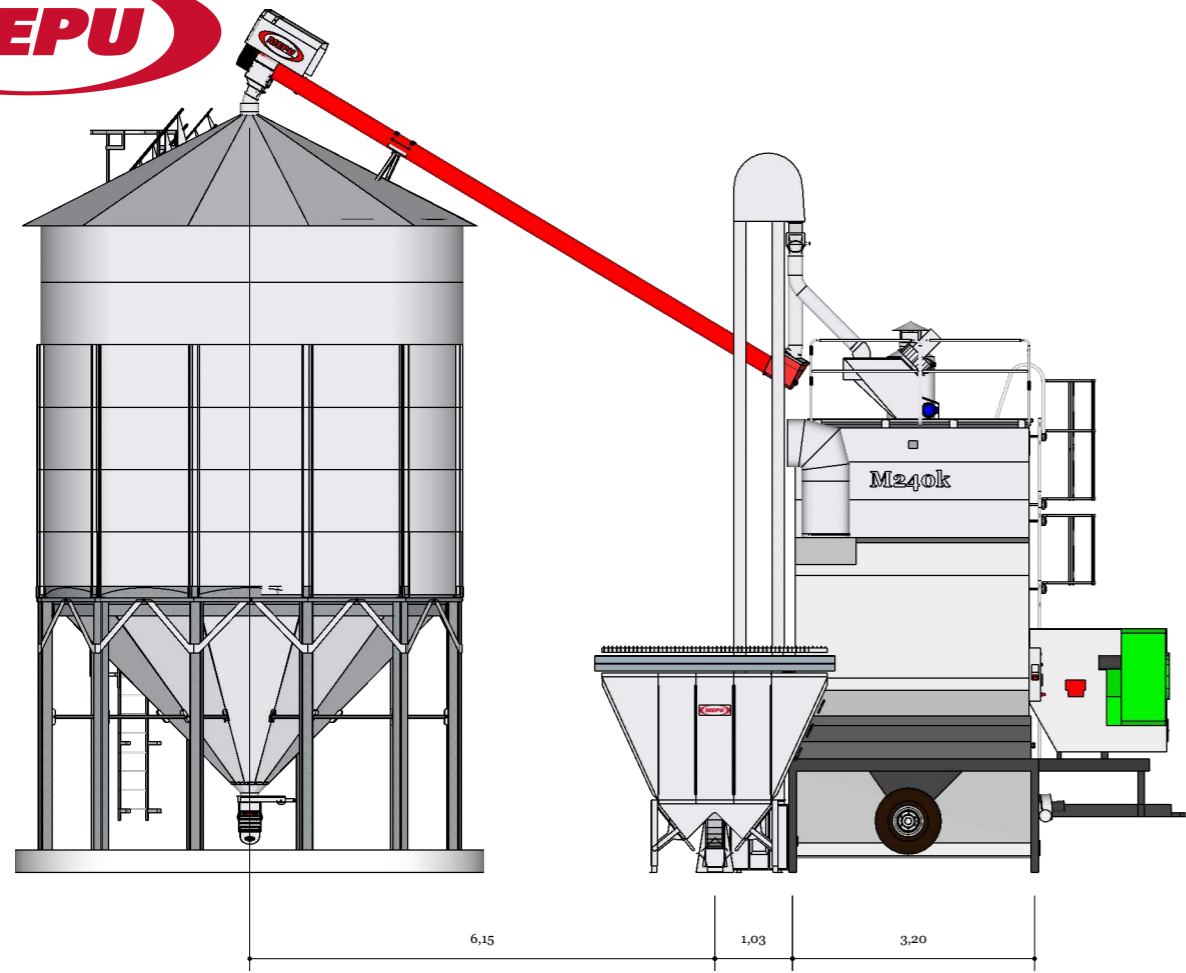

PROJEKTIKUVA.Mikko Härkönen.20230629

ASIAKAS
Mikko Härkönen

PROJEKTI
M: JSm



PROJEKTI NO.

PVM
29.06.2023

SUUNNITTELIJA
Diplomi-insinööri
JHn

KUVAUS
M240k



